

ACCESS DOOR

K60-HAD / K65-CAD Series



APPLICATION

Duct Access Door provides a practical and easy means of gaining access to components inside of ductwork.

FEATURED STANDARD CONSTRUCTION

- **FRAME:**
 - Constructed from 24 Ga (0.7 mm) Galvanized Steel provided with Gasket all around.
- **DOOR:**
 - Constructed from 22 Ga (0.8 mm) Galvanized Steel, double skin type with 1" (25 mm) fiber insulation.
- **ATTACHMENT:**
 - Continuous Hinges for model K60-HAD.
- **LOCKS:**
 - Galvanized cam locks:

	Dimension	
	4"-16"	18"-24"
K60	1 cam	3 cams
K65	2 cams	4 cams

- **FINISH:**
 - Mill Finish.
- **SIZES:**
 - Minimum Size: 4"x4" (101.6 mm x 101.6 mm)
 - Maximum Size: 24"x24" (609.6 mm x 609.6 mm)

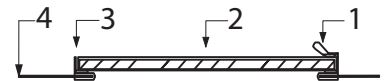

CLOSED POSITION

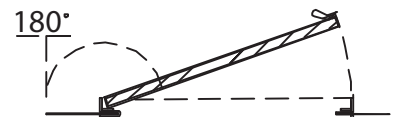
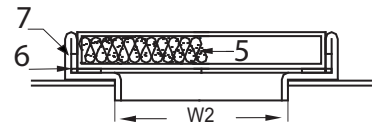

OPEN POSITION

- 1-Cam Lock
- 2-Door
- 3-Hinges (Only for K60-HAD model)
- 4-Duct
- 5-Insulation
- 6-Gasket
- 7-Frame

OPTIONS

- Stainless Steel Construction.
- 2" (50 mm) fiber insulated door depth with 22 Ga (0.8 mm) frame thickness.
- Without Insulation.
- 20 Ga (1 mm) or 18 Ga (1.25 mm) door thickness.
- With Copper or Galvanized Handle.

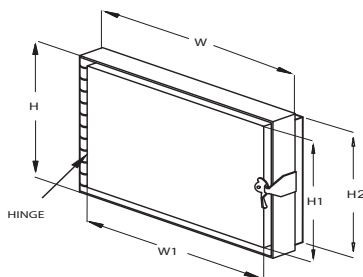

MODEL K60 (HAD)
HINGED, FLUSH DOOR

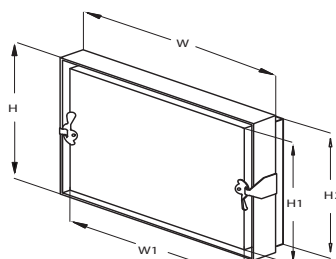

MODEL K65 (CAD)
HINGELESS, FLUSH DOOR AND FLUSH MOUNT ACCESS DOOR WITH MULTIPLE CAM LOCKS FOR DOOR CLOSURE.

ACCESS DOOR

K60-HAD / K65-CAD Series

DIMENSIONAL DATA

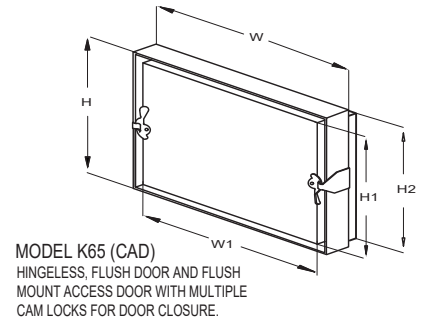
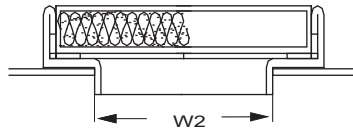
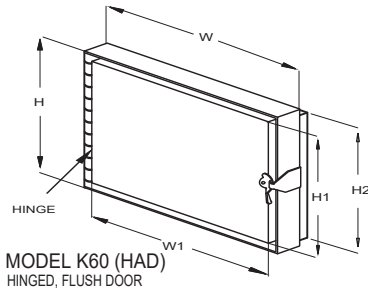

K60-HAD Dimensions					
Outside Frame (Order Size)		Door Leaf		Inside Neck	
W in (mm)	H in (mm)	W1 in (mm)	H1 in (mm)	W2 in (mm)	H2 in (mm)
4 (101.6)	4 (101.6)	3.75 (95.25)	3.875 (98.43)	2.82 (71.6)	2.82 (71.6)
6 (152.4)	6 (152.4)	5.75 (146.05)	5.875 (149.23)	4.82 (122.4)	4.82 (122.4)
8 (203.2)	8 (203.2)	7.75 (196.85)	7.875 (200)	6.82 (173.2)	6.82 (173.2)
10 (254)	10 (254)	9.75 (247.65)	9.875 (250.83)	8.82 (224)	8.82 (224)
12 (304.8)	12 (304.8)	11.75 (298.45)	11.875 (301.63)	10.82 (274.8)	10.82 (274.8)
14 (355.6)	14 (355.6)	13.75 (349.25)	13.875 (352.43)	12.82 (325.6)	12.82 (325.6)
16 (406.4)	16 (406.4)	15.75 (400.05)	15.875 (403.23)	14.82 (376.4)	14.82 (376.4)
18 (457.2)	18 (457.2)	17.75 (450.85)	17.875 (454)	16.82 (427.2)	16.82 (427.2)
20 (508)	20 (508)	19.75 (501.65)	19.875 (504.83)	18.82 (478)	18.82 (478)
22 (558.8)	22 (558.8)	21.75 (552.45)	21.875 (555.63)	20.82 (528.8)	20.82 (528.8)
24 (609.6)	24 (609.6)	23.75 (603.25)	23.875 (606.43)	22.82 (579.6)	22.82 (579.6)
K65-CAD Dimensions					
Outside Frame (Order Size)		Door Leaf		Inside Neck	
W in (mm)	H in (mm)	W1 in (mm)	H1 in (mm)	W2 in (mm)	H2 in (mm)
4 (101.6)	4 (101.6)	3.875 (98.43)	3.875 (98.43)	2.82 (71.6)	2.82 (71.6)
6 (152.4)	6 (152.4)	5.875 (149.23)	5.875 (149.23)	4.82 (122.4)	4.82 (122.4)
8 (203.2)	8 (203.2)	7.875 (200)	7.875 (200)	6.82 (173.2)	6.82 (173.2)
10 (254)	10 (254)	9.875 (250.83)	9.875 (250.83)	8.82 (224)	8.82 (224)
12 (304.8)	12 (304.8)	11.875 (301.63)	11.875 (301.63)	10.82 (274.8)	10.82 (274.8)
14 (355.6)	14 (355.6)	13.875 (352.43)	13.875 (352.43)	12.82 (325.6)	12.82 (325.6)
16 (406.4)	16 (406.4)	15.875 (403.23)	15.875 (403.23)	14.82 (376.4)	14.82 (376.4)
18 (457.2)	18 (457.2)	17.875 (454)	17.875 (454)	16.82 (427.2)	16.82 (427.2)
20 (508)	20 (508)	19.875 (504.83)	19.875 (504.83)	18.82 (478)	18.82 (478)
22 (558.8)	22 (558.8)	21.875 (555.63)	21.875 (555.63)	20.82 (528.8)	20.82 (528.8)
24 (609.6)	24 (609.6)	23.875 (606.43)	23.875 (606.43)	22.82 (579.6)	22.82 (579.6)

ACCESS DOOR

K60-HAD / K65-CAD Series

ORDERING INFORMATION

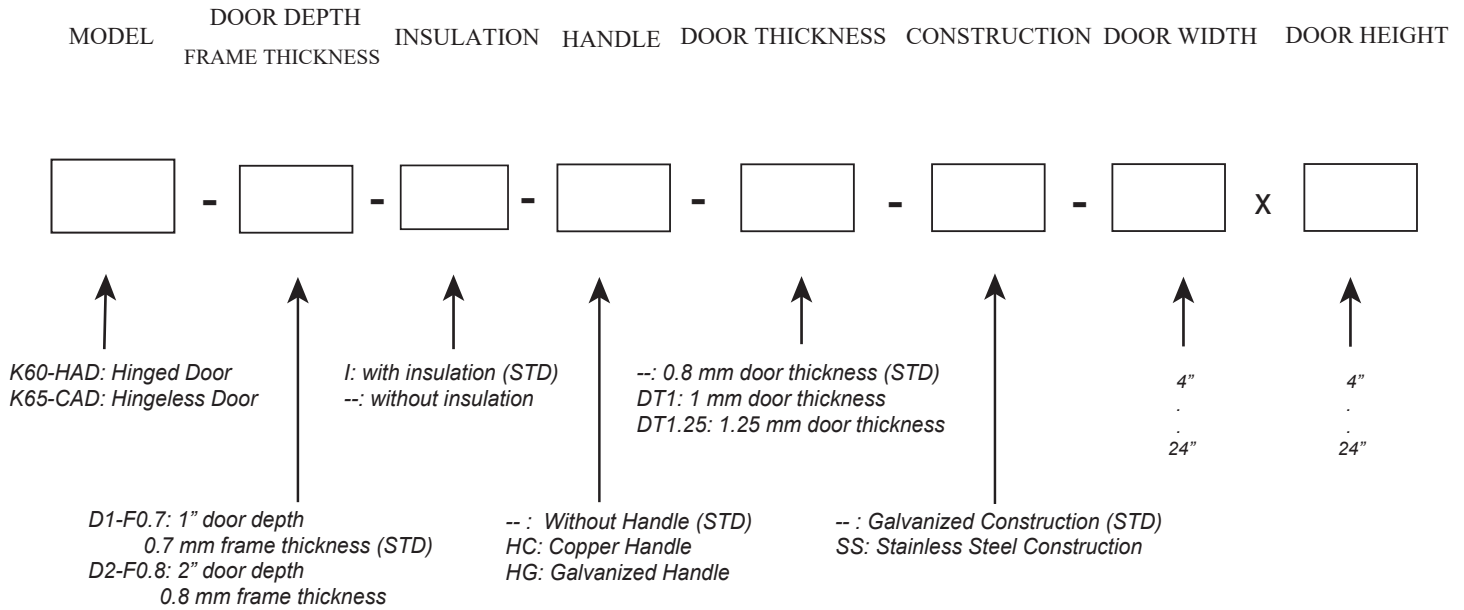

N.B: - For more information, please check the submittal sheet.

N.B: Order size is Outside Frame Size

